

ESP Ψ aegis

aegis was created because we enjoy using NCE PowerCab but we wished it could do more. We really wanted more versatility too.

aegis is a powerful, intelligent integration of DCCconcepts expertise with the versatility of Cobalt Alpha and the wireless abilities of DCCconcepts ESP to provide you the perfect upgrade for your PowerCab System, so it grows with you to allow control of larger layouts.

DCCconcepts ESP **aegis** system is complete, gently embracing & protecting PowerCab while providing a powerful wireless 5-amp DCC control system that enhances it's usability, adding wire-free control abilities, integrating and directly linking DCCconcepts Alpha and ESP accessory potential while adding improved program track abilities. importantly, It also gives modellers a wider range of well managed track voltage output levels to improve train driving results when used with a much wider range of modelling scales.

Your NCE PowerCab retains all of its existing capabilities so there's nothing new to learn, but now it can do it all - better than ever!

about aegis

Working together, The NCE PowerCab and the DCCconcepts **aegis** high power 5 amp wireless system combine to give you a DCC system with exceptional performance and the ability to expand to control the largest of DCC layouts.

We want you to get the best from your DCCconcepts aegis system, so read this manual carefully before turning it on!

First and foremost, DCCconcepts **aegis** adds power, greatly increases interface abilities, enhances overload protection and improves program track management as well as giving you control of track voltage and making your PowerCab into a wireless control system.

However we greatly respect PowerCab and its NCE software so **aegis** does not attempt to modify how your PowerCab operates or interfere with its normal operation.

Happily this also means no need to re-learn everything, because when you use DCCconcepts **aegis** system, your PowerCab will work the same way it always has, so there is very little to worry about other than exploring this manual to get the best from your new DCCconcepts **aegis** system.

So, also keep your NCE PowerCab manual handy as you work through this manual in case you need to refer to it.

(PowerCab is a registered trademark of NCE Corporation)

The DCCconcepts **aegis** owner's manual Index

A first look at the aegis system

- P 2~3 Index and an overview of the **aegis** system.
- P 4~5 A quick start guide - for impatient **aegis** owners.
- P 6~7 **Getting started** - important first steps with **aegis** and considerations when mounting the **aegis** system.

aegis front panel, Power supply, Cap & Lanyard

- P 8~9 The **aegis** front panel and descriptions of front panel switches and connections.
- P 10 Power and Reset/Protection switches & their LEDs.
- P 11 Main and Program track switches & their LEDs.
- P 12 Cab Main and ESP Plus switch and its LED actions.
- P 13 The **aegis** system's front panel connection sockets, when to use them and how to use them.
- P 14 The **aegis** ESP transmitter Pairing switch and LED.
- P 15 The **aegis** ESP wireless transmitter unit and LED.
- P 16 The **aegis** system power supply & power connection
- P17 The Controller Cap and lanyard and the Curly cord.

aegis mounting cases & recommended accessories

- P 18~19 The **aegis** mounting case descriptions & range details
- P 20~21 Recommended **aegis** add-ons and accessories.

aegis Inputs, outputs, settings and connections

- P 22~23 Overview of the **aegis** main board and a closer look at all of its connections.
- P 24 The Power input connectors and their use.
- P25 Main and Program Track connections.
- P26 Command bus connections, The Power Out Switch and the Command bus headers
- P28 Setting the TRACK voltage output headers

The DCCconcepts **aegis** owner's manual Index

- P29 Connections for **aegis** wireless add-on modules
- P30 **aegis**, ready to go, straight out of the box
- P31 Connecting additional controller handsets
- P32 Adding Alpha Central to your **aegis** system.
- P33 Adding Alpha box or boosters to your **aegis** system.
- P34~37 Tips on PowerCab use.. plus some things you just may not know about operating with your PowerCab.
- P38 **aegis** warranty and DCCconcepts contact details



IMPORTANT

REGISTER YOUR **aegis** SYSTEM AND DOUBLE YOUR WARRANTY FOR FREE!

You can do this easily by scanning this QR Code with your phone OR by going to our website and using the **aegis** registration link that is on our home page.
(Please be sure that you fill in all the details requested)

DOUBLE YOUR WARRANTY OFFER

inside the box **aegis**

DCCconcepts **aegis** high power 5 amp wireless system is complete and ready for you to use once you have read the manual, set the **aegis** track voltage, charged the wireless transmitter pack and made the appropriate connections.

The DCCconcepts **aegis** system comes with the following:

- The DCCconcepts **aegis** 5 amp base station - with easy to understand control panel, tightly managed variable track voltage appropriate for any scale, almost unlimited expansion and a full, separate program track ability.
- The **aegis** wireless transmitter - that gives you plug and play wireless connection for your PowerCab with a long range and incredible reliability.
- The special **aegis** Power Supply - that provides full, tightly managed system and track voltages under any load, irrespective of your modelling scale, protecting your valuable electronics, layout and locomotives.
- The **aegis** Controller Cap and Lanyard - protecting your PowerCab and keeping it handy when you need to use your hands for other things around the layout.
- The comprehensive **aegis** instruction manual.

(PowerCab is a registered trademark of NCE Corporation)

Getting Started with your DCCconcepts aegis System (Quick Start guide)

While we strongly recommend you read this manual cover-to-cover before starting to use your **aegis** system, we also know that you are keen to get going, so for those who just can't wait, here is a basic "Quick Start Guide".

- Operating wirelessly will need the **aegis** transmitter battery to be charged, so for now, skip to page **15**, read all about it and get it on charge so it's ready to use later.
- Connect your **aegis** system to the main and program track. See diagram opposite for how to make these connections. *If you are facing the front panel, the two green pluggable connectors for this are at the right hand side of the circuit board.*
- For now, leave the track voltage header at the default level as that will be safe for ALL modelling scales. Later, after reading the manual, you can easily make any final change you wish to suit your running needs and scale. *The header which lets you do this is clearly marked and is positioned at the rear of the circuit board.*
- Connect **aegis** to the **aegis** power supply, then plug the power supply mains lead in to a wall socket and turn it on. *If you are facing the front panel, the **aegis** DC Input socket is located on the left side of the circuit board. It is also clearly marked.*
- Turn your **aegis** system ON by holding down the POWER ON/OFF button on the left hand side for 2 seconds. The illuminated switches on the **aegis** front panel will illuminate, flash then settle down to their operating state in a second or two.
- Now, using your original PowerCab lead, plug your PowerCab into the **aegis** front panel socket marked CAB MAIN and you're ready to select and drive a locomotive. We sincerely hope that you enjoy your first **aegis** experience!

Now you've enjoyed a few minutes of aegis operation...

Getting Started with your DCCconcepts aegis System (Quick Start guide)



Program track has independent overload protection to protect decoders from errors or faulty locomotive installation work!

The main track is fully protected too.

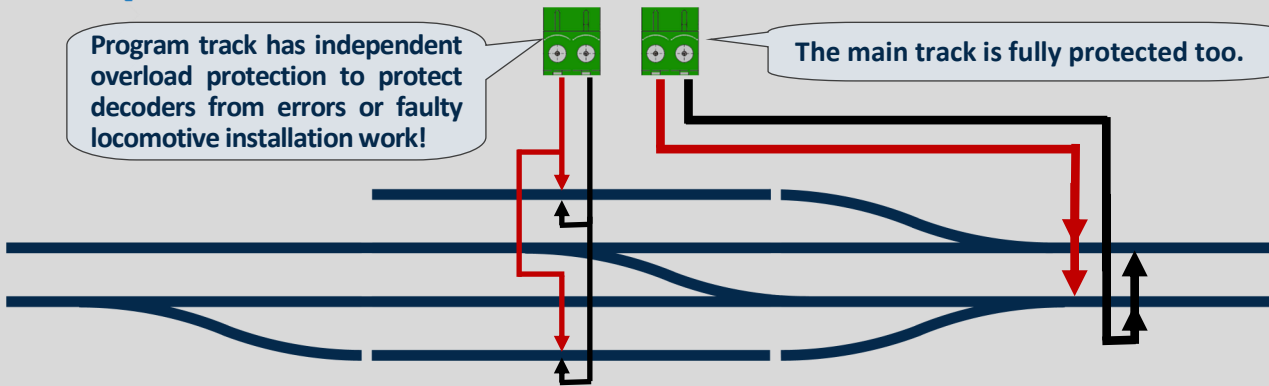

Providing that it is totally isolated from the main track on both rails, your program track can be totally separated, a siding or even be part of a loop as shown above.

- Your **aegis** system automatically isolates the program track when you use the PROGRAM TRACK socket or select PROG using the appropriate track switch.
- If the MAIN switch is activated, the program track automatically reconnects to the main track bus so you can also use that siding or loop for layout operations.

...lets get back to learning how to get the best from aegis!

Getting Started with your DCCconcepts aegis System (Preparation and important first steps)

Before you start to connect aegis, we strongly recommend that you do the following:

- Read this manual, cover to cover, so you are truly ready to go before you connect power.
- Go and find your NCE PowerCab manual, so you have it to hand just in case you need it.
- Register your **aegis** system purchase online. This is really important as it ensures that we can efficiently provide you with service and future software upgrades if they are needed.
Most importantly, properly registering your new **aegis** system purchase will double the standard 1 year **aegis** warranty with no cost to you at all!

One more important step before you continue to read the manual...

Your new **aegis** system has a huge advantage in operating convenience as your PowerCab can now, for the first time, become truly wireless, freeing you from any wired layout connection.

The **aegis** radio transmitter is incredibly efficient and will provide many hours of operation from a single charge as it is equipped with a top quality Lithium Iron rechargeable battery.

However, it can only be shipped with a nominal charge level, so your **aegis** transmitter unit will need a full charge before layout use. This will take several hours, so lets start now!

Charging is easy: Just plug a standard or high capacity USB-C equipped phone charger into your **aegis** Transmitter. The RGB LED flashes BLUE when charging and will turn OFF when fully charged.

Please see page 15 of this manual for detailed information on the aegis wireless transmitter.

Please note: To keep battery charging simple, we have made the **aegis** transmitter circuitry compatible with the standard USB-C connector, also ensuring that its management circuitry is 100% compatible with all USB-C “Fast Phone Chargers” that are now found in almost every household across the world. (Please note: If you do NOT have an appropriate charger, we recommend any charger manufactured by Samsung or equivalent quality mobile phone brand)

OK... With your aegis transmitter battery now on charge, sit back, relax and read on.

Getting Started with your DCCconcepts **aegis** System (Where should you mount your aegis system?)

Panel Mounting: The **aegis** system has been designed for panel mounting and we have made sure the **aegis** fascia height matches that of other DCCconcepts layout control products such as the Alpha Meter and Alpha Panel perfectly, so they will look great together on your layout fascia.

*You can find easy to use cut-out templates for **aegis**, Alpha Meter or Alpha Panel on our website by using this QR Code.*

*(Or, If you do not want to scan the code, please use the **aegis** accessories link we have added to our website home page to take you where you need to go).*

Case Mounting: We also understand that some modellers prefer to have their controllers mounted in an attractive case, so we have created a smart looking case especially for use with your **aegis** system.

Even better, you can extend the **aegis** case at any time with other, additional case units pre-cut ready for other **aegis** products, Alpha Panel and Alpha Meter.

There is even a very useful uncut or blank add-on case option so that you can add other layout switches or accessories to create something uniquely yours.

We have also created an “angle mounting kit” that will let you set the case angle at 10, 20 or 30 degrees for a very professional look!

*You can find images and other details of the cases for **aegis**, Alpha Meter, Alpha Panel or your choice of add-on items on our website by using this QR Code.*

*(Or, If you do not want to scan the code, please use the **aegis** accessories link we have added to our website home page to take you where you need to go).*



AEGIS ACCESSORIES



AEGIS CASES

**Also see
manual
page 18**

ESP
Ψ
aegis

Installing the **aegis** System

THE **aegis** FRONT PANEL

Elegant brushed aluminium with laser etched branding, it features stylish illuminated switches to keep you in touch with what's happening with your **aegis** DCC system and its unique ESP wireless communications.

DCCconcepts **aegis** is also perfectly matched to DCCconcepts Alpha Meter and Alpha Panel to ensure you can create a professional looking installation on your layout fascia with all your DCCconcepts products.

We've even created a case for it for those who prefer to keep their **aegis** separate to the layout. (DCC-ACS)

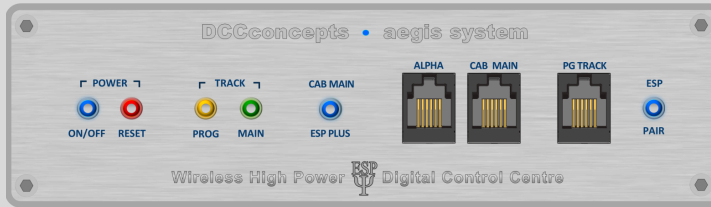

INSTALLING YOUR **aegis** SYSTEM ONTO THE LAYOUT FASCIA

installing your **aegis** system is easy to do if you plan, take your time and measure carefully before cutting.

Decide where on your fascia you wish to mount **aegis**, checking that there is also clear space behind it for the control board - PLUS enough space to allow you to easily attach or plug in the cables needed for add-on items.

INSTALLING YOUR **aegis** SYSTEM INTO THE OPTIONAL CASE

Before installing your **aegis** system into the DCC-ACS case, read these instructions carefully then set your preferred track output voltage by moving the track voltage control Header (Page 28) to the appropriate position.

The case has pre-prepared screw holes. Carefully insert your **aegis** system into the case and secure it to the case fascia with the screws provided. There is no need to overtighten the screws, a gentle, firm hold is enough.

POWER RELATED SWITCHES

ON/OFF SWITCH: Press and hold for 2 seconds to turn your aegis system ON.

PROTECTION RESET SWITCH: If there is a short circuit, this LED will turn RED and FLASH.

Complete information & detail for these switches on page 10

ALPHA AND CAB SOCKETS

RJ12 SOCKET: Connect another NCE PowerCab or an appropriate DCCconcepts Alpha range product to these sockets: This gives you more options for control of your layout control when using **aegis**.

Complete detail for these Connectors on page 13

PROGRAM TRACK SOCKET

RJ12 SOCKET: Connect an NCE PowerCab here for direct access to the program track.

(Then press PGM, 4, then ENTER key on your NCE PowerCab to enter program track mode)

Complete detail for this Connector on page 13

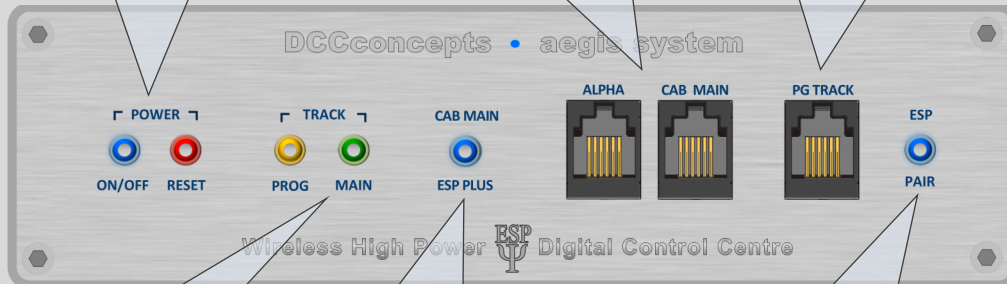

TRACK POWER SWITCHES

SELECTION SWITCHES: You can manually choose to power the main or program track by using these two interlocked switches. The active track selection LED will show GREEN to confirm selection.

Complete information & detail for these switches on page 11

CAB MAIN/ESP SWITCH

The switch LED will show various colours depending on the cab connection type and status of the DCC Power Bus. It can also work as an “emergency stop” button if held for 3 seconds.

Complete information & detail for this switch on page 12

ESP PAIRING SWITCH

When pressed and held, this switch activates the pairing of an ESP transmitter unit and the aegis base station.

The LED has several states to indicate pairing or ESP activity.

Complete information & detail for this switch on page 14

THE aegis POWER SWITCHES

Once you have connected the **aegis** DCC system and its power supply, these two switches will control the power on/off cycle and also clearly indicate the power status of your **aegis** DCC system.

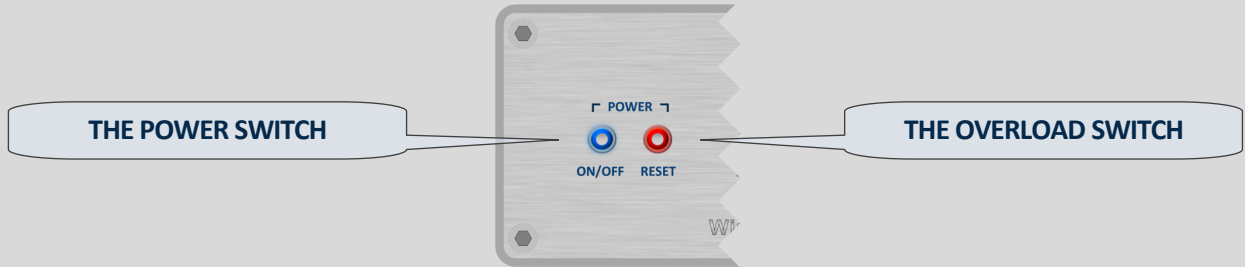

THE POWER SWITCH

- Press and hold for 1 second to turn **aegis** ON.
- Press and hold for 3 seconds to turn **aegis** OFF.

All LEDs will initialise in BLUE, changing to their normal state operating colour as the system initialises.

The RGB LED in the ON/OFF switch will remain BLUE as long as your **aegis** system is active & working normally.

BUT - If there is a short circuit/overload on your layout, power will be interrupted and this LED will turn OFF to show you there is no power being delivered to the layout.

(The RESET switch LED will become RED and pulsing at 2HZ if there is an active overload or short circuit problem)

When the overload is removed and the RESET button has been pressed for 3 seconds to restore track power, the ON/OFF switch LED automatically turns on again, showing a steady BLUE light when track power has been restored.

THE RESET SWITCH

- During the “powering up” process, the RGB LED in this switch is BLUE, but once the system stabilises and all is well, this LED will automatically turn OFF.
- If there is a short circuit or overload on the layout during turn on or during layout operation, the rack power will turn OFF, the RESET LED will become RED and it will flash steadily at approximately 2 HZ.
- Once the short circuit or overload has been cleared, press the RESET switch for 3 seconds to restore the track power. If successful, this LED will now turn OFF. (and the BLUE Power Switch LED will turn on again)

The AMBER “Caution” mode: If the loading on your layout approaches a constant 80% of system power or more, this LED will let you know by changing to AMBER. (Everything works better if not overloaded, so we suggest that it may be time to add another power booster to your system)

THE **aegis** PROGRAM TRACK AND MAIN TRACK SWITCHES

Program Track mode for NCE PowerCab

To program a locomotive, put the PowerCab into “Program tTrack mode” in 3 simple steps!
Press PROG/ESC, Press Key #4, Press ENTER
When you finish programming, simply remove the cable from the “PROG” socket and your NCE PowerCab will automatically return to operating mode when you re-connect it.

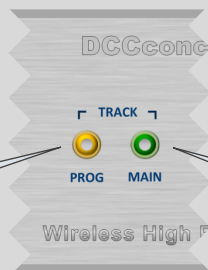

THE PROGRAM TRACK SWITCH

THE MAIN TRACK SWITCH

THE PROGRAM TRACK SWITCH

The “PROG” or Program track switch & the “MAIN” or Main track switch are interactive, so pressing the “PROG” switch turns off the Main Track connection.

Please be sure that you have correctly connected the “Main Track” and “Program Track” outputs of your **aegis** DCC system to the layout and correctly isolated the programming track with breaks in both rails.

If you have done so, then your **aegis** DCC system will automatically act as follows.

- If the “PROG” switch is ON (LED is GREEN) then the Main track will be turned OFF and the Program track will be isolated and active.
- If the “PROG” switch is OFF (LED is AMBER) then the main track and the Program track siding are both connected to the Main track bus and the program siding is usable for normal operations.

THE MAIN TRACK SWITCH

The “MAIN” or Main Track switch and the “PROG” or Program Track switch are interactive, so pressing the “MAIN” switch turns off the Program Track connection.

Please be sure that you have correctly connected the “Main Track” and “Program Track” outputs of your **aegis** DCC system to the layout and correctly isolated the programming track with breaks in both rails.

If you have done so, then your **aegis** DCC system will automatically act as follows.

- If the “MAIN” switch is ON (LED is GREEN) then the Main Track and the Program Track siding are both connected to the Main Track bus and the program siding is usable for normal operations.
- If the “MAIN” switch is OFF (LED is AMBER) then the Main Track will be turned OFF and the Program Track will be isolated and active.



REGISTER TODAY!

THE aegis CAB MAIN / ESP PLUS SWITCH

An easily used emergency stop for all Locomotives and an indication of the Cab Bus Status

IMPORTANT

REGISTER YOUR aegis SYSTEM AND DOUBLE YOUR WARRANTY FOR FREE!

You can do this easily by scanning this QR Code with your phone OR by going to our website and using the aegis registration link that is on our home page. *(Please be sure that you fill in all the details requested)*

DOUBLE YOUR WARRANTY OFFER



Cab Main ~ ESP Switch

CAB MAIN EMERGENCY STOP SWITCH USE

Sometimes you need to stop all trains quickly, but don't want the track power bus to also turn off as you need to change turnouts etc.

- Press & hold this switch for 3 seconds & your aegis system will instantly send a global "STOP" command to all locomotives.
- The CAB MAIN SWITCH LED will turn RED and flash at 1 HZ while sending STOP Commands.
- The System will continue to broadcast STOP until you cancel the STOP condition
- To cancel STOP commands, press this switch again. Your aegis will then immediately return track power bus communication to its normal condition.

ESP and CAB BUS STATUS INDICATIONS.

During normal operations, this LED also indicates the activity status of the cab or Command Bus.

- STEADY BLUE: aegis system is receiving an active wireless ESP command signal.
- SOFTLY PULSING BLUE: aegis system is on ESP standby and it is NOT currently receiving any active wireless ESP command signals.
- STEADY GREEN: aegis system is receiving signals from a wire-connected PowerCab.
- STEADY AMBER: There is NO cab communication or the track power bus is NOT connected.
- FLASHING RED: Emergency STOP is activated.

Your aegis system can STOP all active locomotives just by pressing the CAB MAIN button

THE **aegis** FRONT PANEL CONNECTION SOCKETS

Direct interfaces for NCE PowerCab in main or program track mode and Cobalt Alpha

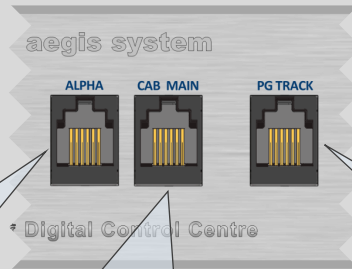

COBALT ALPHA SOCKET

This socket is for Cobalt Alpha only.

We have added it to the front panel as sometimes, you may want to plug a Cobalt Alpha product like an Alpha Central into the front panel. (Either to use it while hand-held or perhaps to power it up while programming or changing addresses ~ other settings.

Note: This RJ-type socket has active connections to only the inner 4 terminals so it cannot be used for other products or purposes.

Note: To maximise your connection ability there are 2 more Alpha sockets on the rear of your **aegis** system.

DCC CAB MAIN SOCKET

This socket is for an NCE PowerCab.

The DCCconcepts **aegis** system has been designed to give you a wide range of options for adding additional NCE PowerCab handsets.

Use this socket to add a wired NCE PowerCab or any other device that is designed to be added to the DCC bus.

Note: This RJ-type socket has active connections to all 6 of its terminals.

Note: To maximise connection ability there are more CAB sockets on the rear of your **aegis** system. They are usable for ALL your other connections including DCCconcepts Alpha Panel.

PROGRAM TRACK SOCKET

This socket is ONLY for programming.

The DCCconcepts **aegis** system adds a properly interactive Program Track ability that is missing from PowerCab!

You can use this socket only with a plugged-in, wired NCE PowerCab.

After plugging the NCE PowerCab into the socket, press the "PROG" button, then, using the NCE handset, press PROG, 4, ENTER to put your NCE PowerCab into Program Track mode.

Note: You cannot use the program track wirelessly. To use the program track, you **MUST** plug your NCE PowerCab lead into this socket.

THE aegis ESP PAIRING SWITCH

One-step pairing of your DCCconcepts aegis wireless transmitter and your NCE PowerCab

Plug the Transmitter lead in HERE for direct pairing

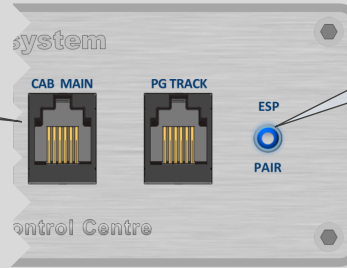

ESP PAIRING switch. Press for 3 seconds to start pairing

This handy clip will attach the aegis transmitter to your belt

PAIRING THE aegis TRANSMITTER UNIT

SIMPLE PAIRING USING AN RJ12 CABLE

This is a simple process that only needs doing once..

- Make sure the transmitter battery is charged. Press the **aegis** transmitter switch to turn it on.
- Using the PowerCab RJ12 cable, plug one end into the **aegis** transmitter and the other end into the CAB MAIN socket on your **aegis** unit.
- Press & hold the switch on the **aegis** transmitter for about 3 seconds. (The LED flashes BLUE @ 1HZ).
- Press and hold the ESP PAIR switch on the **aegis** unit for 3 seconds. (The LED flashes GREEN @ 1HZ).
- When pairing is complete, both of the LEDs return to a steady BLUE state.
- Now turn the transmitter OFF (Press the switch for 6 seconds). The pairing operation is now complete.



USB-C CHARGING

Charge the transmitter battery by connecting it to a USB-C fitted phone charger. The LED will do a BLUE double flash while it is charging. (The LED will turn off when it is fully charged)



RJ12 CONNECTION

This RJ12 connector is used for pairing of the **aegis** transmitter to an aegis base station and for the connection of your PowerCab. We recommend our Curly Cord DCD-ACL for this.

THE aegis WIRELESS TRANSMITTER UNIT

The **aegis** wireless transmitter is self-contained and contains a Lithium Iron battery and an ESP transmitter. Once it is paired with your **aegis** and your PowerCab is plugged into the **aegis** transmitter, train control can now be truly wireless. Even better, with the hard work of powering your layout being done by the **aegis** main unit, your PowerCab uses a lower working voltage, never needing to carry any real power and so it will have an extended life!

Clipping the **aegis** wireless transmitter to your belt and adding the Cap and Lanyard to your PowerCab also gives you the best of both worlds - a wireless handset and somewhere to keep it safe when you unexpectedly need to use your hands to re-rail a train for other things around the layout.

A fully charged **aegis** wireless transmitter will last for an entire day of operating on most layouts (all operators are a little different, however even with heavy use, expect more than 6 hours active operations per charge). Please note that battery charging is carefully managed for a long life and a full charge will take several hours. (overnight is best)

Transmitter LED indications:

- LED is GREEN and flashing @ 1Hz: The Transmitter is ON and establishing communication with the receiver.
- LED is steady BLUE: The Transmitter is ON, the battery has plenty of charge and it is ready to go.
- LED Alternates BLUE and AMBER @ 1Hz: All is still OK, but battery is lower than 20% charge. consider charging it.
- LED has an AMBER double flash @ 2Hz: Battery has reached a very low charge level and it is time to charge it.
- LED Alternates GREEN and AMBER @ 2Hz: The battery level is TOO LOW to operate. You must charge it NOW.



USING THE aegis TRANSMITTER UNIT

With the **aegis** Transmitter is charged and paired, we are ready to go.

- Connect the **aegis** Transmitter to your PowerCab with the RJ12 lead.
- If the LED is OFF, then you will need to press the **aegis** Transmitter switch for 1 second to turn it on. The LED will soon settle to a steady BLUE.
- Clip the **aegis** Transmitter unit to your belt.
- Use the standard PowerCab actions you already know to drive your trains, change settings with PROGRAM ON THE MAIN or change accessory decoders.
- When your layout operating session is finished, turn the **aegis** transmitter off to save the battery. To do this, press and hold the switch for 6 seconds.

POWERING YOUR aegis: THE aegis 5 AMP 24 VOLT REGULATED DC POWER SUPPLY

The proper choice of power supply can be a really significant factor in ensuring long DCC system life and real performance, irrespective of which modelling scale you choose to work with.

The **aegis** system is designed to tightly control its outputs so you have access to enough power & voltage for larger scales like O and Gauge 1 while delivering lower voltages with the luxury of enough power for a whole layout for the smaller HO, OO, TT or N gauge models. **aegis** also carefully manages power & voltage to your PowerCab so that it never sees the stresses it did while you used it with its original power supply!

Importantly, because it will never be stressed to its limits, the aegis power supply will run cool and last.

Think of it like having a car with a powerful motor - super smooth for relaxed cruising, but enough power for those times you want to make it work harder or react effortlessly to every press of the accelerator.



WORLD WIDE COMPATIBILITY

The **aegis** power supply meets all international safety standards.

Every **aegis** system will arrive complete with the correct power cord for the country of delivery, so that you can simply open the box and get going.

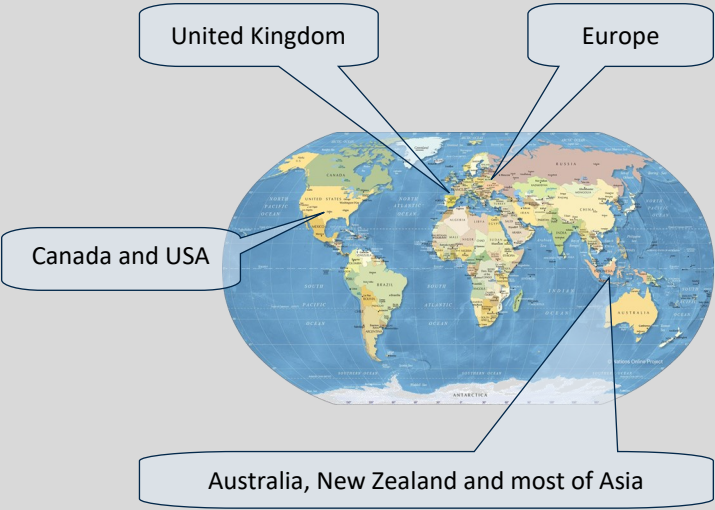

Use it ONLY with aegis please. Other brand DCC systems may not tolerate this output voltage

The very useful CAP and LANYARD - Part # DCC=PCL

These two simple items alone will make a huge difference to the way you operate your layout.
(By the way - the Cap and Lanyard works equally well with PowerCab, ProCab and ProCab-R)

The **aegis** Cap and Lanyard don't just hold the PowerCab and keep it conveniently to hand - They also make sure it cannot be dropped and gently protect the vulnerable LCD display.

(A broken display screen when a PowerCab is dropped is the most common causes of PowerCab damage).

By the way... the Lanyard is adjustable so it fits well for operators of all sizes and it features a strong and easy to use "Snap clasp" so you can choose to operate or drive your trains without the lanyard attached if you prefer, returning it to the lanyard only when you need your hands to re-rail a train or do other things around the layout during an operating session.

It is also perfect for your club or exhibition days too, as you'll never misplace your DCC controller again!

Maybe it is time for you to Consider using a Curly Cord

Your original 6' PowerCab connection cable works just fine, but a 6 foot cord does tend to get in the way a little, and now you have the **aegis** system and you can connect wirelessly, you just don't need all of that length.

There are other advantages to the smart **DCCconcepts DCD-ACL curly cord** - slightly better voltage delivery and cleaner DCC signal thanks to its combination of twisted and curled cable that helps to reduce wiring induction.



THE aegis CONTROL PANEL CASE RANGE

aegis is ready to install into your layout fascia, however we understand that some modellers may prefer to mount their **aegis** system and other layout control items in an enclosure, so we have created a stylish range of easy to use matching control enclosures for you to choose from.

Designed to link together with a choice of presentation angles and all cables exiting at the rear, these attractive cases give you a simple way to quickly create a very professional control panel.



Part # DCD-ACS
The **aegis** main unit Case

YOU can choose the case mounting angle!

Each case is able to be mounted flat on the shelf, but you can also choose the mounting angle as we have included an angle adapter set with every case.

This angle adapter kit includes options to set your case at multiple different angles. It adds a really professional touch to your creation. (examples on next page images)

ALL of these **aegis** cases can be linked together, so that you can easily create a really professional panel.





Part # DCD-ACP

Matching and directly connectable to the **aegis** main unit case, this case is designed to mount the DCCconcepts Alpha Panel, the **aegis** ESP PLUS panel and the **aegis** ESP Accessory Panel.

Part # DCD-ACM

Every DCC layout user will benefit from installing a meter to accurately measure the track voltage & the layout current draw. Directly connectable to the other **aegis** unit cases, this case is designed to mount the clever DCCconcepts Alpha Meter.



Part # DCD-ACB

Most layouts will probably also have some other switches or gadgets that need to be panel mounted. Directly connectable to the other **aegis** unit cases, this case has a blank front panel to let you choose what you want to mount and where to mount it.



You can easily re-colour your aegis cases to suit your own preference!

We chose an attractive dark GREY colour but its an easy task to change it if you wish. Prepare by wiping it all over with alcohol to remove any contamination, undercoat with an automotive undercoat spray can and then, while you can still smell undercoat solvent, add your choice of finishing colour then let it dry. A job well done!

PLEASE NOTE: Images shown here are taken of the case during the design stage and minor details may change

RECOMMENDED aegis ACCESSORIES

Your **aegis** system is ready to go right out of the box, but there are some additional add-on items you may want to look at to make your layout operations even better!

Search "**aegis** ACCESSORIES" or by Part number on our website for full details, pricing and availability

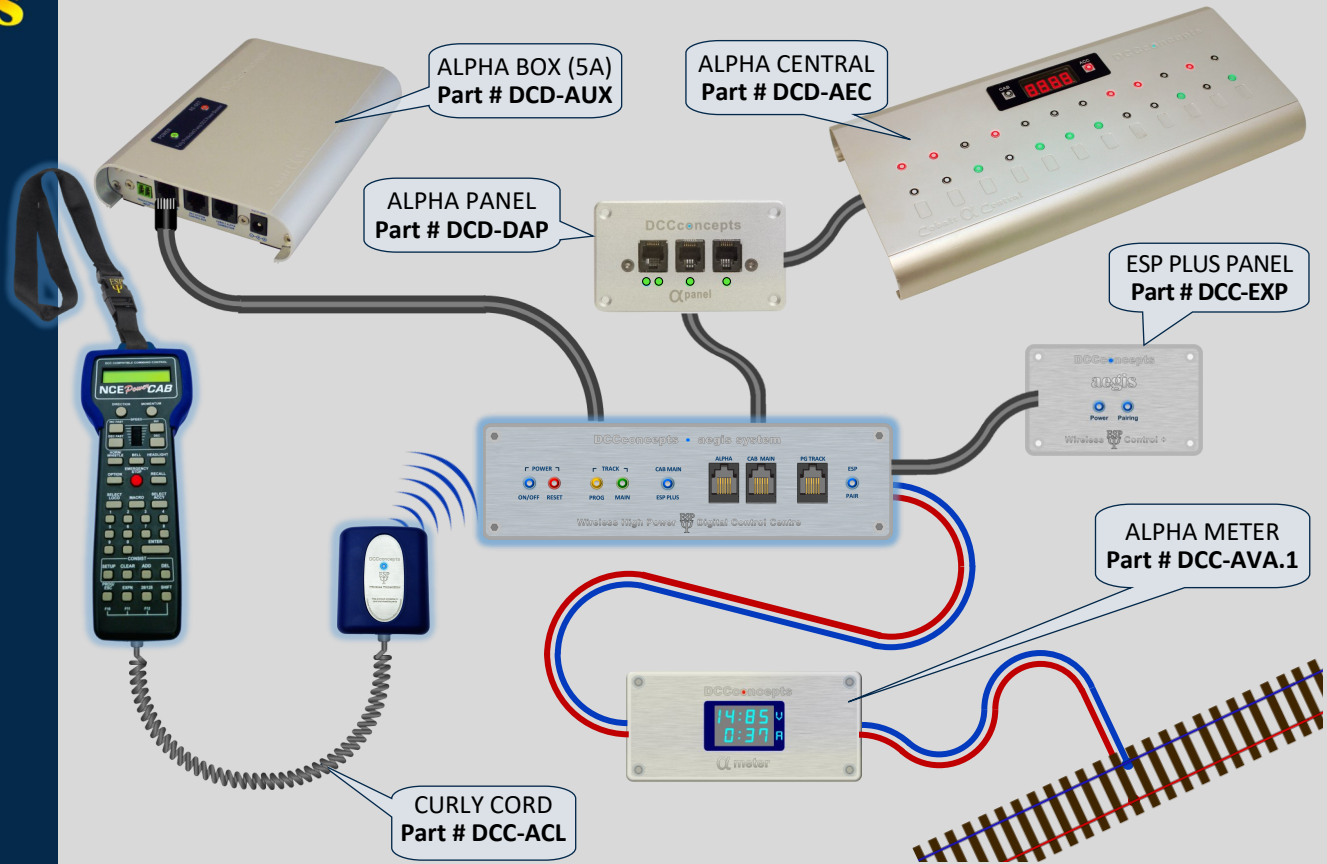

ALPHA BOX Part # DCD-AUX

If you have a larger layout, or if the constant load on your **aegis** system gets up to 4 amps or more, then it is time to add a second Power District to your layout.

DCCconcepts Alpha box is a 5 amp system booster with top quality protection built in.

ALPHA CENTRAL Part # DCD-AEC

Controlling accessories and turnouts is a snap with the Alpha Central. Almost literally “Plug and Play, you’ll be changing turnouts just 5 minutes after you open the box!

Alpha Central is a 12 address DCC accessory controller. Many can be linked together.

ALPHA METER Part # DCC-AVA.1

It is comforting to be able to monitor track voltage as well as how much current is being drawn across the layout.

Alpha meter simply installs between control system and the track, and features chunky plug-in connectors so wiring is really easy.

ALPHA PANEL Part # DCD-DAP

You may want to connect additional wired PowerCab, Power Pro or engineer handsets. Or perhaps add an Alpha Central or similar item to the command Bus.

DCCconcepts Alpha Panel is the perfect way to do this when added to an **aegis** system.

ESP PLUS PANEL Part # DCC-EXP

If you want another wireless DCC control unit, the ESP+ Panel makes that easy to do. The ESP Plus panel is supplied complete with a Wireless Transmitter, cap & lanyard so everything you’ll need is in the box.

CURLY CORD Part # DCC-ACL

Now your Controller is wireless, that 6 foot flat cable may just be a bit inconvenient.

We think you should consider this really capable and highly efficient curly cord as it is perfect for use between PowerCab and the **aegis** wireless transmitter.

ESP

aegis

aegis Accessory Range

BEHIND THE PANEL. THE **aegis** PCB. KEY CONNECTIONS AND CONFIGURATION CONTROLS
(OVERVIEW OF ALL **aegis** CIRCUIT BOARD CONNECTIONS & CONTROLS)

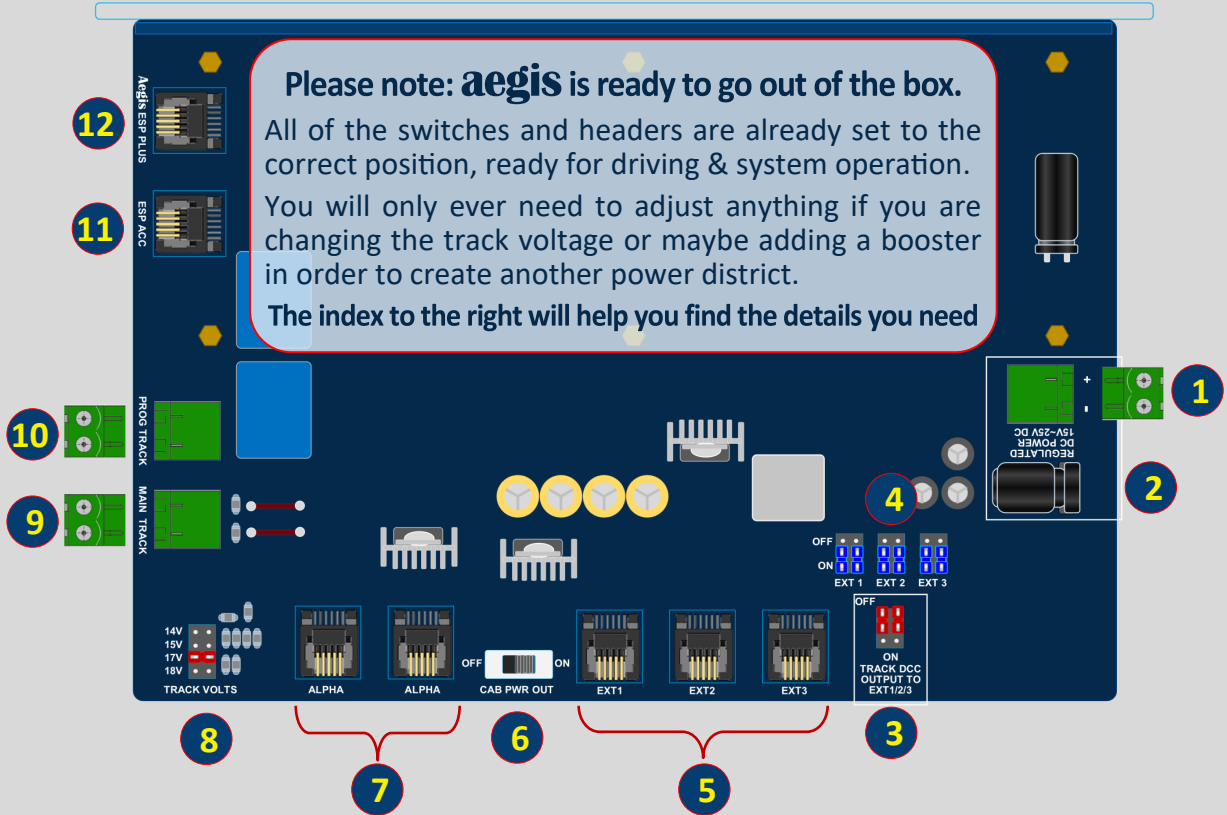

BEHIND THE PANEL. THE **aegis** PCB. KEY CONNECTIONS AND CONFIGURATION CONTROLS (OVERVIEW OF ALL **aegis** CIRCUIT BOARD CONNECTIONS & CONTROLS)

1 **SEE PAGE 24:** These are Power Supply inputs. The Power supply provided with your **aegis** system plugs into #2. Please note, **aegis** requires a regulated DC Power supply for best performance.

2

3 **SEE PAGE 26: Change ONLY after checking the manual.** Headers 3 and 4 are preset to allow other handsets to be added to the DCC control bus. Change ONLY needed for Alpha Box booster type add-ons.

4

5 **SEE PAGE 26:** These are the Command Bus sockets for layout UTP panels, Engineers throttles and Pro Cabs. They are ready to go for this. **Power boosters may need changes in headers - see pages 32 & 33**

5

6 **SEE PAGE 26:** This switch modifies outputs and adds Cab Power out to the Command Bus sockets. Most will never need to do this, so... **Please change ONLY if really needed after checking the manual.**

6

7 **SEE PAGE 27:** These are the output connectors for use with DCCconcepts Alpha Central and similar products. They can also be connected to a DCCconcepts Alpha panel allowing remote connection.

7

8 **SEE PAGE 28:** This set of headers allows you to easily change the track voltage to suit your choice of modelling scale and operating conditions to match **aegis** to the boosters on other power districts.

8

9 **SEE PAGE 25:** These are Program and main track outputs. Both Main and Program Track are fully protected from overload and short circuits. Please see more details on the appropriate manual page.

9

10

11 **SEE PAGE 29:** These clearly marked inputs are for the addition of a second wireless transmitter and an ESP Accessory receiver so that you can easily extend the wireless capability of **aegis** even further.

11

12

BEHIND THE PANEL. THE **aegis** PCB. KEY CONNECTIONS AND CONFIGURATION CONTROLS
(THE CONVENIENT, PLUGGABLE, **aegis** POWER SUPPLY INPUTS)

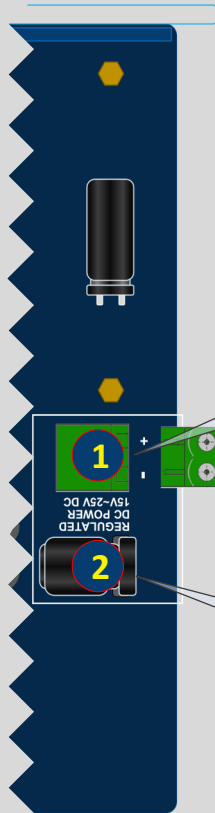

1: You can use these terminals point to connect a power supply without a DC barrel connector if you wish.

However the power supply must deliver regulated DC and only ONE power supply can be connected at any time.

This input is clearly marked with the required polarity and is also protected against accidental reverse connection.

This system requires use of the 24 Volt DC Power Supply provided order to deliver the high voltage output levels needed to run larger scale models.

As a guide, if you use any other supply, expect a track power output about 4 Volts below the output level of your chosen alternative power supply.

Please take care with power supply choices as non-warranty damage may occur if you choose to use and connect an unsuitable power supply.

2: The **aegis** 24V, 5 Amp Power Supply should be connected here.

BEHIND THE PANEL. THE **aegis** PCB. KEY CONNECTIONS AND CONFIGURATION CONTROLS
(THE CONVENIENT, PLUGGABLE, **aegis** MAIN & PROGRAM TRACK OUTPUTS)

10: The PROGRAM TRACK Connection point. Connect your program track to this easy to use connector. The Program track has overload and short circuit protection. Please use an appropriate wire size.

The **aegis** system requires a 24 Volt DC input in order to deliver the higher voltage output levels needed for larger scale models.

As a guide, you can expect a main track bus power output of about 4 Volts below the claimed output level of your chosen alternative power supply.

Please take care with power supply choices as non-warranty damage may occur if you choose to use and connect an unsuitable power supply.

9: The MAIN TRACK connection point.

Connect your system to the layout using this easy to use connector.

The main track has interactive overload and short circuit protection that will alert you if the overall layout load is approaching 80% of system power output. Use the appropriate wire size for the track bus.



BEHIND THE PANEL. THE **aegis** PCB. KEY CONNECTIONS AND CONFIGURATION CONTROLS
(**aegis** COMMAND BUS CONNECTIONS, PWR OUT SWITCH & RELATED HEADERS)

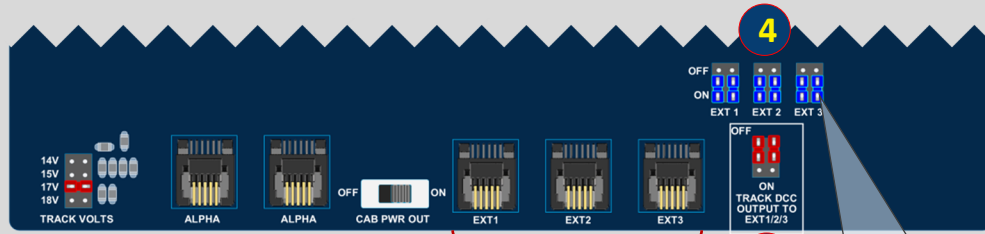

6: The Cab Power-out Switch.
This switch turns on power to the 3 sockets on the Cab Bus.
This switch should be left turned ON for most applications.
It should be turned OFF only if you are using the DCCconcepts Alpha Box to create additional power districts on your layout.

5: You can use the EXT 1, EXT 2 and EXT 3 sockets to connect all your additional handsets including PowerCab, ProCab, Cab 06, Cab 04 or the ProCab wireless base station if you wish. **Please use a 4-wire "Cab" version of the RJ12 flat cable for this.**

Please note that most modellers will be able to just leave all of the switches above at their default settings

4: Headers for EXT 1, 2 & 3
These headers must be ON if you wish to use the EXT 1, EXT 2, EXT 3 sockets.
To turn OFF EXT 1, EXT 2 or EXT 3 Socket, just move the appropriate headers to the OFF position.

3: The track DCC Output headers controlling the output extensions EXT 1, 2 and 3 is usually **OFF**.
Change this header to ON only if you are using DCCconcepts Alpha Box to add a power district. (When you are connecting the Alpha Box, please note that you will also need to select "RJ12" on the Alpha Box's input selector switch)
Otherwise, leave this header OFF. If you set it ON do NOT connect a PowerCab with a 6-wire cable to EXT1, EXT2 or EXT3. (a 4-wire RJ12 cable is OK)

BEHIND THE PANEL. THE **aegis** PCB. KEY CONNECTIONS AND CONFIGURATION CONTROLS
(aegis ALPHA ACCESSORY BUS CONNECTIONS and TRACK VOLTAGE SELECTION)

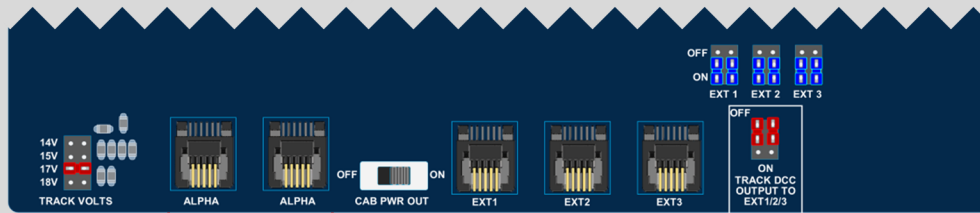

7

The DCCconcepts ALPHA CONNECTIONS
Connect Alpha Panel, Alpha Central or
the Alpha AEU and similar products here.

Control-wise you could connect many Alpha products, however each added product draws a small amount of power, so if you add more than 3, we suggest that you also add a 12v regulated DC wall plug type power supply to the barrel socket on Alpha panel to support the bus load. **We recommend DCCconcepts DCP-PS12.**



This is the incredibly easy to use Alpha Central.
Alpha Central commands 12 accessory addresses, and it is
ready for you to use on address 1 ~ 12 straight out of the box.
 Many Alpha Central units can be connected to any layout as they support all accessory addresses between 1 and 2044. No matter how many turnouts you have, Alpha Central can cope!

Alpha Central's Part # is DCD-AEC

ESP

aegis

aegis PCB connections

BEHIND THE PANEL. THE **aegis** PCB. KEY CONNECTIONS AND CONFIGURATION CONTROLS
(THE SIMPLE, EASY TO USE **aegis** TRACK VOLTAGE SELECTION HEADER)

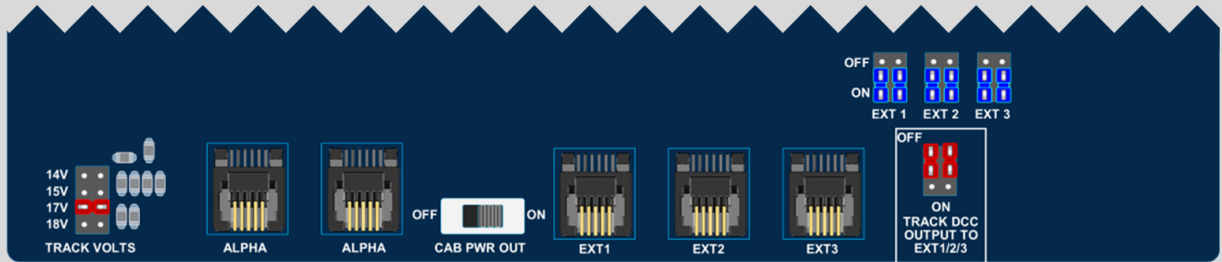

8

How to change track voltage

- Stop all trains on the layout
- Turn your **aegis** system off by pressing the Power switch.
- Disconnect/un-plug the GREEN main track power connector.
- Move the RED track power header to the new voltage level you have chosen and press it firmly in place.
- Reconnect the GREEN main track power connector.
- Turn your **aegis** system on.

If you have power districts & boosters, you should match the track voltage of aegis to the track voltage of your added power boosters.

All decoders are more than capable of handling all of the voltage options provided by your **aegis** system and all of your models will run just fine at the default of 17V, so your final choice will really depend on the scale that you model in, the size of your layout and the nature of your model railway operations.

- Unless you are running larger scale trains, we recommend that you just leave the track voltage setting at the 17V default.
- Z or N scale will be happy there, but a short line or switching layout may benefit from lowering it to 14V or 16V.
- HO or OO scale models are generally also OK at 17V, but if you run mainly high speed European or Japanese trains, try 18V.
- Gauge 1 or O gauge may however run best on and prefer 18V.
- **DO NOT** change the header position unless the power is OFF.

**BEHIND THE PANEL. THE aegis PCB. KEY CONNECTIONS AND CONFIGURATION CONTROLS
(CONNECTING ADDITIONAL aegis ESP WIRELESS EXTENSION MODULES)**

The **aegis ESP Plus** panel connects here and allows you to easily add a second DCCconcepts **aegis** wireless PowerCab to your layout.

The **aegis ESP Plus** panel matches the style of the aegis system and is easy to mount on the layout fascia. There is also a custom designed case if you prefer. The **aegis ESP Plus** panel set is supplied complete with the transmitter, a 750mm connection lead, the controller cap, lanyard and mounting screws.

The **aegis ESP Plus** panel part number is DCC-TX-Set

12

The **aegis ESP Accessory** receiver panel connects here and directly integrates the ESP wireless information it receives into the DCC system and on to the bus.

(ESP transmitters can attach to almost any device on the layout with a switch. They simplify wiring and give the ability to report wirelessly to your DCC system)

The **aegis ESP Accessory** panel matches the style of the aegis system and is easy to mount on the layout fascia. There is also a custom designed case if you prefer.

The **aegis ESP** accessory panel is supplied to you complete with the receiver, a 750mm connection lead and mounting screws.

The **aegis ESP Accessory** panel part number is DCC-EXP

11



IMPORTANT

REGISTER YOUR aegis SYSTEM AND DOUBLE YOUR WARRANTY FOR FREE!

You can do this easily by scanning this QR Code with your phone OR by going to our website and using the **aegis** registration link that is on our home page. *(Please be sure that you fill in all the details requested)*

DOUBLE YOUR WARRANTY OFFER



REGISTER TODAY!

aegis

(READY TO GO RIGHT OUT OF THE BOX)

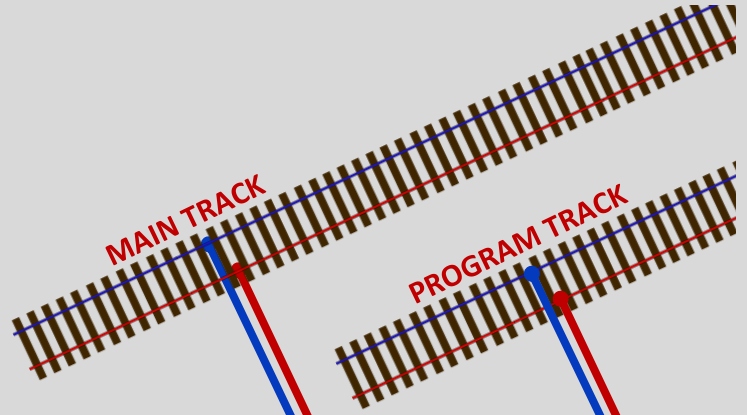
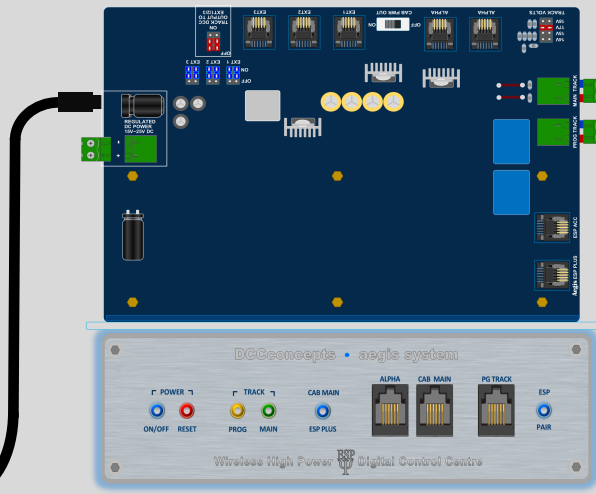

THE WIRELESS (MASTER) POWERCAB MUST BE SET TO CAB NUMBER

2



Your own PowerCab is shown here. PowerCab is not Supplied with aegis

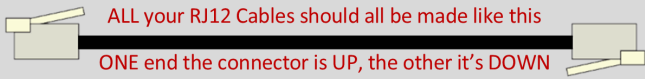

ALL your RJ12 Cables should all be made like this

ONE end the connector is UP, the other it's DOWN

aegis

(ADDING MORE HANDSETS)

THESE CABS MUST EACH HAVE THEIR OWN NUMBER (say 3, 4, 5)

THE POWERCAB MUST BE SET TO CAB NUMBER

2

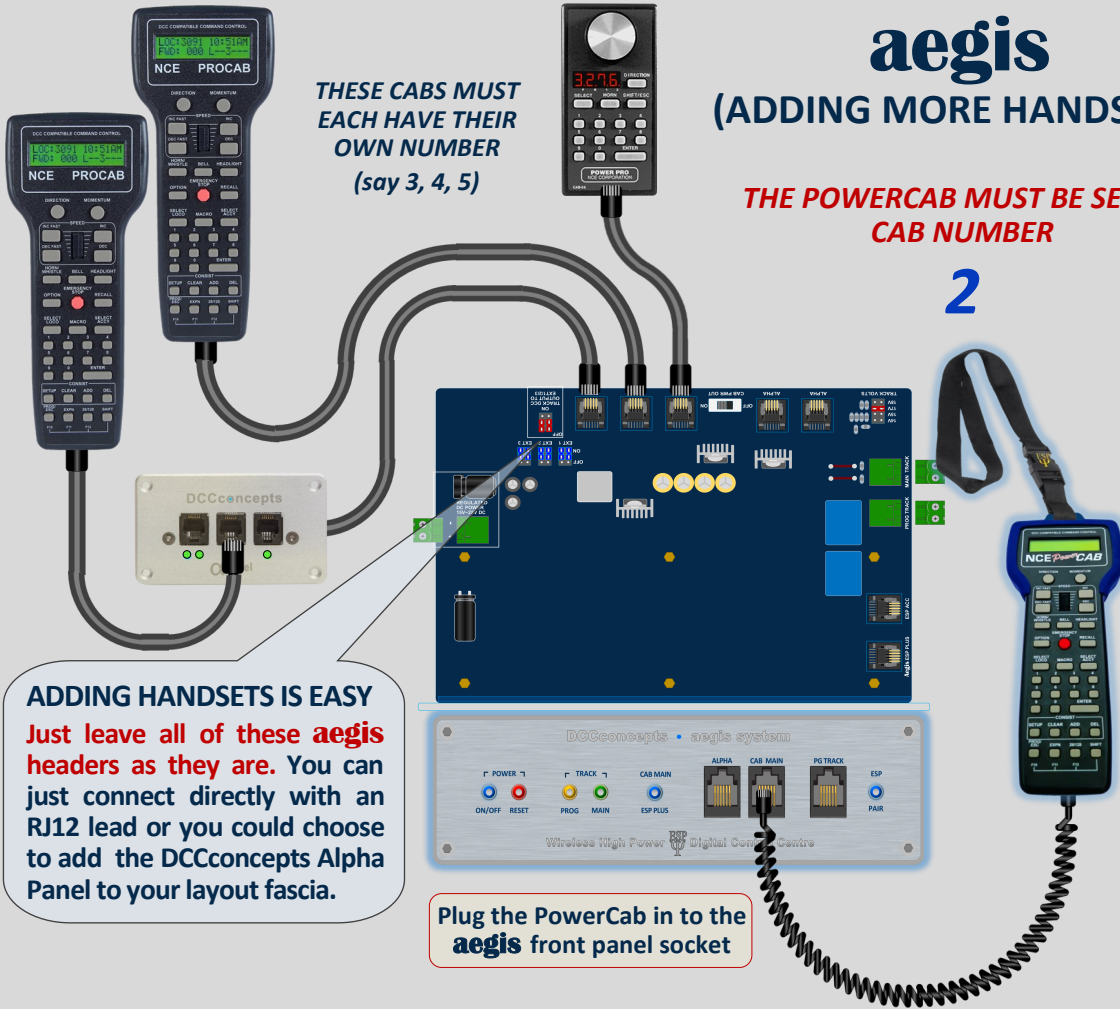

ADDING HANDSETS IS EASY
Just leave all of these aegis headers as they are. You can just connect directly with an RJ12 lead or you could choose to add the DCCconcepts Alpha Panel to your layout fascia.

Plug the PowerCab in to the aegis front panel socket



ADDING ALPHA IS EASY
Use the **ALPHA RJ12 sockets**
You can connect the Alpha Central turnout controller to the Alpha RJ12 sockets on the rear of the board, to the Alpha socket on the **aegis** front panel or add an Alpha Panel to the layout fascia.

aegis
(ADDING ALPHA CENTRAL
TURNOUT CONTROL)

aegis

(ADDING ALPHA BOX
TYPE BOOSTERS)



Remember to move the slide switch at the end (above the green terminals) to the RJ12 position

With the header moved, you CAN still add another handset here, but please DO NOT USE the standard 6-wire PowerCab cable. It is OK to use a Pro Cab type cable which is still an RJ12 - but it has ONLY the 4 centre wires connected.

Set this Switch to the OFF position

Move the RED headers to the ON position

NOTE THE NEW RED HEADER POSITION

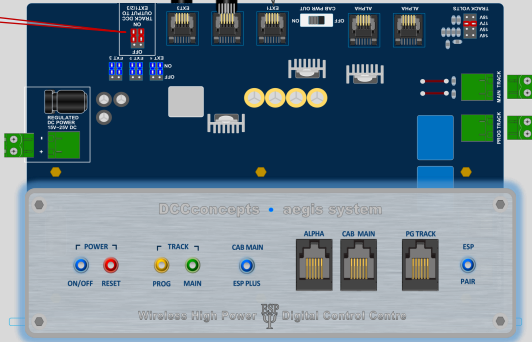
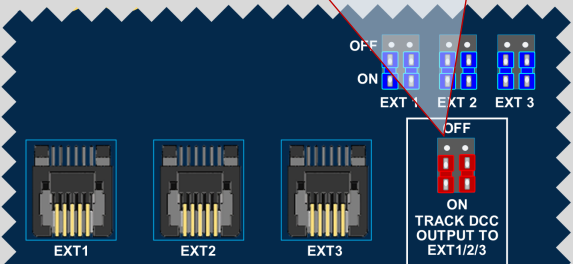

A helpful short guide to KEY common PowerCab questions (All stimulated by questions we often receive from new NCE PowerCab users)

The NCE PowerCab is our favourite DCC starter set.

Testing & references are done with a PowerCab which uses NCE software version 1.65.

If yours is earlier, both NCE & DCCconcepts offer upgrades.



Choosing locomotive addresses

You have the choice of short or long addresses, but which is best?

It's a good question with an easy answer based on logic.

SHORT addresses: They are fine if you have a model of a small private railway/railroad with just a couple of loco's... but you have real limits with short addresses. The actual range is 1 to 127, but your PowerCab will automatically assign numbers from 127 down to consists, so you should really think of short addresses as 1 to 99 in reality.

LONG addresses: With a range of 128 to 9999, and with many prototypes using 4 digit or longer addresses for their locos, using a long address lets you use a model's actual cab-side number for an address so you will always know what number it is at a glance. Simple really!

Your NCE PowerCab manual will show you how to set addresses.

The very handy "RECALL" button

RECALL is a helpful shortcut for accessing frequently used loco's and its also a great way to operate helper locos for long trains...

For 2 locos... enter the number for your first loco, then confirm it with ENTER and press the RECALL button (The display will now show 000).

Now press SELECT LOCO, enter the number for your second loco and confirm it.

If you press RECALL now, PowerCab will toggle between the two, allowing you to drive them both with a simple one-button swap.

PowerCab's default is 2 loco's in the recall stack but you can change it to 6!

Its not in the manual, but here's how. Enter the cab set-up menu by pressing PROG/ESC and then pressing BUTTON 6 followed by ENTER. Press ENTER once more and you are at the RECALL Screen. Press BUTTON 6 to set recall to 6 then press PROG/ESC once more to go back to normal train driving again.

A helpful short guide to KEY common PowerCab questions (Still confused? The NCE PowerCab manual you have is also there to help you)

Why is there an asterisk (*) beside my locomotive number?

(or... I KNOW I set the address to 6, but when I call up loco 6, it won't move)

This is the leading zero problem: a loco address should not normally be entered with any zeros added before the number... but mistakes happen and then things just will not work as you think they should.

So, if you accidentally added a zero, calling up short address 6 won't work because your loco actually now has a LONG address of 006 which shows on screen as *006. So, if you DO see that asterisk on the screen, pop the loco back onto the program track, re-address it with NO leading zeros and all should be well again!

Of course, you might actually WANT to take advantage of the fact that a leading ZERO can actually be a valid number. (but remember, if you add a zero while setting a LONG address, entering 0006, 006 or 06 - then you'll need to select loco 006 to call it up and the display will then show *006.

So: You can have one loco on SHORT address 6 and another on LONG address 006 (*006) if you want.

All just another weird possibility in the world of DCC Digital model railways :-)

EXTEND function control ability and access all 28 functions!

(Using the OPTION key to give you direct access to all of the other functions on your sound decoders)

Out of the box this is NOT enabled as the OPTION button is set up as a BRAKE button, but its an easy task to set the OPTION button up as a function extension key and it only needs doing once.

- Enter CAB SET UP by powering down then holding the SELECT LOCO button while plugging your PowerCab back in. Press ENTER several times until you see a screen that says PROG OPTION KEY and then enter the number 122 then press ENTER. Now, Unplug and then re-connect your PowerCab.
- Now, if you press the OPTION button ONCE, the lower line of the screen will show F10-F19 & TEN will be added to any number you enter on the keyboard - For example, if you enter 7, **F17** will activate.
- If you press the OPTION button TWICE, the lower line of the screen will show F20-F28 & TWENTY will be added to any number you enter on the keyboard - For example, if you enter 5, **F25** will activate.
- To exit the function extension control, press the PROG/ESC button once to control F0 to F9 again.

A helpful short guide to KEY common PowerCab operations
(We thought we'd save you the effort of getting the NCE PowerCab Manual out)



Checking & Setting the PowerCab Cab Number

NCE uses a system of "Cab numbering" so the system knows which handset is issuing locomotive or accessory commands to the layout. This simple system works well but you should be aware of it as you may need to change control handset numbers as your layout grows.

Here is what you need to know and do:

If you have only one PowerCab, it will probably already be set at the default number 2... so you can just carry on and enjoy driving trains.

Or - If you have more than one cab handset but you will only ever use the **aegis** wireless transmitter and the front panel socket on **aegis**, then you can also just carry on operating without any need to change.

However:

If you have more than one handset and you will connect it by using it directly or via an Alpha Panel or NCE UTP panel connected to the REAR sockets of the **aegis** System, then you WILL need to change the Additional handset CAB Numbers. This only needs doing once.

Here is how it is done:

- Unplug the PowerCab or ProCab handset. (For the NCE engineer throttles, refer to their respective manuals)
- While holding down the SELECT LOCO button, plug it in again.
- When the Cab boots, you will see the Cab number on the screen.
- Without adding any zeros, choose a number between 3 and 6 for the additional handset.
- Press the PROG/ESC key on the handset to return to the normal operating mode and drive your trains with the handset.

A helpful short guide to KEY common PowerCab operations (We do think you should re-read the whole NCE PowerCab Manual though)

Using the **aegis** system and the PowerCab to program your decoders

Your NCE PowerCab can already do it, but until now, it did not have a separate or properly protected programming track ability. Adding **aegis** adds a new dimension and even allows your program track to operate as a part of the layout when it is not needed for locomotive or decoder programming.

*(We will show you how to ENTER programming modes here. For full detail on what you can do and how to do it, please read the excellent NCE PowerCab manual. Also: for the Program Track instructions, we will assume you have already correctly connected **aegis** to both the main & your programming track)*

Program on the Program track: ALWAYS start here if it is a NEW locomotive or decoder because the **aegis Program Track has protection that may well save your decoder if there is an installation error!**

- Plug the PowerCab directly into the RIGHT side PG TRACK socket on the **aegis** fascia panel then press the PROG switch under the word TRACK on the **aegis** fascia panel (the TRACK switch LED will turn GREEN and the MAIN Track switch LED will turn AMBER as it automatically turns the Main Track off)
- Place your locomotive on to the Programming Track, press PROG/ESC, Press 4 then press the ENTER button to enter the Program Track mode.
- Follow the instructions on the screen for next steps. If you are unsure about changing specific decoder CVs, please refer to the DECODER manufacturers instructions. If you are unsure about how to use the controller, please refer to the excellent NCE PowerCab instruction manual.
- When finished with using the Program Track, unplug your PowerCab, press the MAIN switch on the **aegis** front panel then reconnect PowerCab to either the **aegis** transmitter unit or the **aegis** front panel.

Program on the MAIN Track can be great for setting up speed etc. (operational mode programming or OPS):

- Just press the PROG/ESC Key. The screen will now show OPS PROG and the number of the current loco.
- Press ENTER and you will be given a choice for the next step (1= Set address, 2=CV, 3=Config CV29) If you need any other options, press ENTER and you will get a full list of the 9 available “on the main” options.
- So - now just follow the screen prompts, carry out your desired changes then press ENTER to confirm.
- When you are finished with programming on the main, press PROG/ESC to exit programming.

Your aegis system has been designed, created and is warranted by DCCconcepts Ltd.

Every DCCconcepts **aegis** system and accessory has been made to the highest standard. All DCCconcepts products are extensively tested at all stages of manufacture. Live testing is also carried out immediately prior to packing of every unit so we are sure that your **aegis** system will work as it should out of the box.

Should you experience unexpected difficulties please first read the manual carefully and try again. If you are still concerned, are unsure or just cannot resolve your problem or if you need further advice please contact us either by telephone on +44 (0) 1729 821 080 between 10.00am and 5pm UK time (Monday to Saturday).

If you wish, you can also email us at sales@dccconcepts.com. As we can be exceptionally busy from time to time, if you email us please (a) use the word **aegis** in the email title line and (b) add your telephone contact number and convenient call times so we can give you the fastest and most efficient service possible.

In relation to warranty service:

- **The aegis** warranty is 12 months from date of purchase, however if you have fully registered your **aegis** system this is extended to 24 months providing all requested details have been given when registering.
- **The aegis** system has no user serviceable parts. All service will be carried out by DCCconcepts Ltd. Please note - you should if possible re-pack the **aegis** system in its original box if it is necessary to return it for service as this will give the best protection. Please also note that the **aegis** wireless transmitter contains a Lithium Ion battery which must be more than 80% discharged prior to packing or shipping it to us.
- No connections to or disconnections from the **aegis** system should be done unless the power is off. Use of the incorrect power, wrong use of the header connections on the main circuit board or other careless connections and usage OR any form of environmental damage will invalidate this product warranty.



**REGISTER YOUR aegis SYSTEM AND
DOUBLE YOUR WARRANTY FOR FREE!**

Scan this QR Code with your phone or go to our website and use the **aegis** registration link that is on our home page.

Please be sure to fill in all of the requested details. Once verified we will send you a confirmation of your extended warranty.